



CURE IT[®]
GRP WATERPROOFING SYSTEM

Installation Guide

**Installation, handling, storage
and technical information**

Summary of features

- 20 year materials guarantee from the manufacturer
- 20 year workmanship guarantee from the installer
- Optional 10 year insurance-backed guarantee available
- Fire retardant (to BS476-3:2004)
- Proven pedigree as a waterproofing material with the potential to last for the lifetime of the building
- Made from specially formulated resins and topcoats designed for roofing applications
- Superb appearance - available in a range of colours
- Three finish options including non-slip
- Can be used for almost any application regardless of size or complexity
- Straightforward to install
- Good environmental profile
- High security - cannot be cut with a knife
- Cold applied - free of the risks associated with 'hot works'
- Maintenance free
- No seams, joints or welds
- Easy to repair in the unlikely event it is damaged
- Completely UV resistant
- Can be used to convert an existing flat roof for use as a balcony or roof garden
- Can be used to permanently contain water for applications such as ponds or pools
- Will withstand foot traffic as standard
- Can be specified to withstand heavy, frequent foot traffic for walkways/balconies
- Can be used for almost any application, including: flat roofs, industrial applications, pitched roofs, walkways, balconies, green roofs, steps or complex gulleys/gutters

www.cureit.com



Training is recommended before using the Cure It system

CONTENTS	PAGE
Cure It Data Sheet	4
Key Steps to The Perfect Cure It Roof	5
Component Parts of a Cure It Roof	6
Tools and Materials	7
Stages of Installing a Cure It Roof	8
Stage 1 - Laying the Deck	9
Stage 2 - GRP Edge Trims	10-13
Stage 3 - Laminating	13-15
Stage 4 - Topcoating and Finishing	16
Hardener Addition	17
Material Quantity Estimation	18
General Advice	19
Troubleshooting	20-23
Warm Roof Part 'L' Specification Guidance	24
GRP Trims	26

General information

Cure It Data sheet

Product description

A Cure It GRP roof is a single-ply GRP laminate consisting of Cure It Roofing Resin and Reinforcement Mat applied in situ over a good quality OSB3 deck. The roof is finished with pre-formed GRP edge trims and a coat of pre-pigmented Cure It Topcoat.

Material features

- Materials are specially formulated for roofing applications
- 20 year guarantee on materials
- Fast 'wet-out'
- Low styrene emission
- High flexibility
- Adjusted for seasonal variations in temperature
- Good topcoat bonding characteristics
- Includes technical support
- Full training and on-site support available
- Supplied pre-pigmented Graphite Grey (BS 00 A 13)
- Range of colours available
- Fire retardant to BS476-3:2004 (no restrictions on usage)
- Suitable for foot traffic applications with 600g/m² Reinforcement Mat

Longevity

The Cure It roofing system materials (Cure It Roofing Resin, Cure It Roofing Topcoat, Roofing Edge Trims, Hardener, Reinforcement Mat) will remain within the specification of the Cure It Material Safety Data Sheet when stored correctly and will form a structural waterproof membrane that will remain watertight for a period of 20 years from the date of manufacture when installed as specified in the conditions set out in the Cure It guarantee.

Properties in relation to fire

A flat roofing system comprising of a Cure It GRP laminate with Cure It Topcoat when tested to BS 476-3 : 2004 was designated EXT.FAB (no limitations on use). F.AA rating is available with the exposed aggregate finish.

Resistance to wind uplift

The Cure It GRP roofing system is fully-bonded to the roof substrate. The system will be resistant to any wind uplift that could reasonably be expected during the product's lifespan.

Areas of usage

The Cure It waterproofing system can be used for waterproofing applications of almost any size or complexity.

Warm roof specification

The Cure It system can be specified to comply with current part 'L' regulations. (see page 24)

Resistance to foot traffic

In standard 450g/m² specification the Cure It system will be resistant to any level of foot traffic that it could reasonably be subjected to during its lifespan. 600g/m² specification is available for applications subject to heavy foot traffic such as walkways/balconies.

Finish options

The Cure It waterproofing system is supplied to BS4800 00 A 13 Graphite Grey. There are two non-slip options available: exposed aggregate (granulated non-slip slate coating applied at 0.75kg/m²) and coated aggregate finish (granulated non-slip slate coating applied at 0.15kg/m²).

Standard Specification

OSB3 18mm T & G
Cure It Roofing Resin @ 1.5kg/m²
Cure It approved Reinforcement Mat
Cure It Roofing Topcoat @ 0.4kg/m²
Cure It Hardener (1-4%)
Cure It GRP edge trims
Trim adhesive applied around the perimeter
Applied as per the Cure It Installation Manual

General information

Key steps to the perfect roof

Installing your first roof

Training is always recommended before installing a Cure It GRP roof. Training is available either on-site with a trained and experienced installer or can be arranged with your distributor. Please contact Cure It technical on 03301 222666 to book onto a training course or contact your distributor for further details.

Key steps to the perfect roof

After reading this manual please refer to this page. Always remember the following key rules when installing a Cure It GRP roof. These are areas where mistakes are most commonly made:

Decking

- When using OSB3 18mm T & G boards always lay the boards with the tongue and groove gap face up (usually writing face up).
- Always stagger the joints.
- Do not use sections of boards less than 400mm.
- Leave a 25mm expansion gap against any walls (this will be covered by the fillet trim/flashing).
- Non T & G boards need to have joints gapped as per the manufacturers instructions then taped (with masking tape) and bandaged (laminated bandage across the joints).
- For all decking use ring shank nails or screws (nailgun recommended) to penetrate 40mm into the joist at 200mm centres on each joist.

GRP Edge Trims

- When fixing the GRP edge trims always use trim adhesive to bond the trims around the perimeter. Without trim adhesive, the trims will pull up onto the roof and are difficult to fix.
- GRP edge trims should be used around the entire perimeter of the roof.
- Use an expansion joint (E280 trim) if the roof is over 100m².

Applying the Cure it Resin/Reinforcement Mat

- Bandage all joints between trim sections and between trim and decking.
- Do not use Cure It roofing materials in wet or damp conditions or apply onto any damp or moist areas. They WILL fail.
- Never apply Cure It directly onto brickwork.
- When dealing with a complicated detail that isn't covered in this guide call the Cure It technical support team (details on back cover).
- When the Cure It Resin and the Reinforcement Mat have been applied, lightly sand the entire area with 40 grit sandpaper before topcoating.
- Always have a large visqueen sheet on site. In the event of rain STOP and cover the roof with the sheet.
- Always stir the resin and topcoat thoroughly in the can before use.
- Hardener is required for both the Resin and Topcoat.
- Always measure the hardener from a safety dispenser. Use suitable protective goggles and gloves when handling the hardener.
- Before laying the Reinforcement Mat, ensure that the area has been coated with Cure It Roofing Resin. Do not lay Reinforcement Mat onto a dry deck.
- The laminate should become transparent when consolidated with the paddle roller. Apply more resin if the reinforcement mat is too dry (still white).

Topcoating/finishing

- Don't forget to add hardener to the topcoat.
- Apply the topcoat within a day of the laminate.
- Wipe the surface with acetone if it has been left over night.
- Lightly sand the area and acetone wipe if it has been a couple of days.
- Follow the re-topcoating notes on this guide if the roof has been left any longer.
- Do not apply resin or topcoat onto surfaces above 35°C.

General information

Component Parts of Cure It Roof

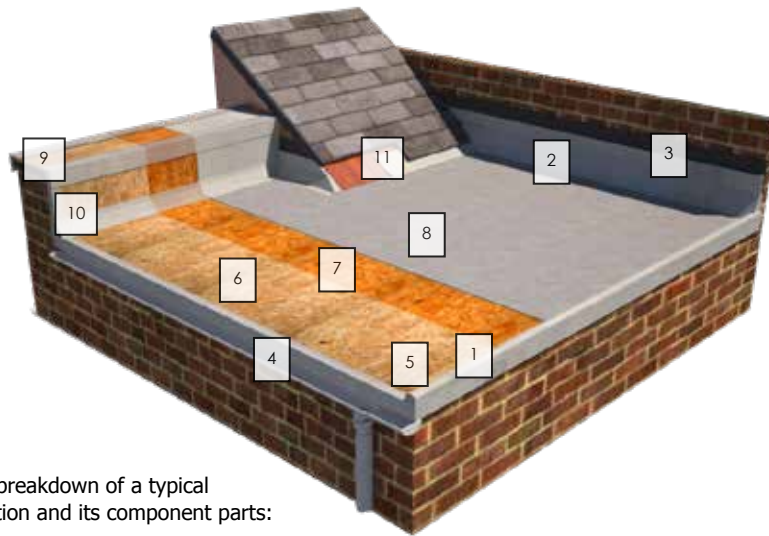

This diagram shows a breakdown of a typical Cure It roofing installation and its component parts:

- | | |
|--|--|
| 1 B260 Raised edge trim | 7 Cure It laminate comprising of roofing resin and roofing mat |
| 2 D260 Fillet trim | 8 Cure It Roofing Topcoat |
| 3 C100 Simulated lead flashing | 9 AT 195 External Angle Trim |
| 4 A200 Drip edge trim | 10 D260 Fillet Trim |
| 5 C1 universal external corner | 11 F300 Flat Flashing |
| 6 2400mm X 600mm X 18mm OSB3 Tongue and Groove decking | |

Most Cure It roofing installations are for simple domestic flat roofs like the one shown below. Roofs like these incorporate the four most commonly used trims: A200, B260, C100 & D260. The roof shown below has been finished in a pigmented green topcoat with an exposed aggregate finish.

- 1 C100 Simulated lead flashing.
- 2 The edge of this roof was masked off before the aggregate finish was applied.
- 3 C1 preformed universal external corner.
- 4 C4 Preformed universal internal corner.
- 5 A200 drip trim - Laid to facilitate water running off the roof.
- 6 A slight fall is engineered into the substrate to avoid standing water.
- 7 B260 Raised edge trim.
- 8 D260 - laminated into the substrate, remains unattached behind the C100 flashing.



General information

Tools and Materials

Roofing tools

- Cure It mixing bucket
 - Brushes
 - 70mm + 140mm rollers
 - Consolidating rollers/paddle roller
 - Hardener safety dispenser
- For easy measurement of materials and hardener addition
Required for detail work
These can be extended with a Cure It extension pole
These can be extended with a Cure It extension pole
This is an essential tool for safe hardener addition

Cure It roofing materials

- Cure It Roofing Resin
 - Cure It Topcoat
 - GRP Edge trims
 - Cure It Reinforcement Mat
 - Bandage
 - Cure It Hardener
 - Acetone
 - Trim Adhesive
 - Finishing Tissue
- This is available in Graphite Grey as standard (BS 00 A 13) or a selection of pre-pigmented colours
This is available in 2 weights: 450g/m² for most roofs and 600 g/m² for applications where the roof will be subjected to heavy foot traffic (i.e. a walkway or balcony.)
Hardener can be supplied in different strengths to compensate for seasonal variations in temperature
This is used to achieve a high quality finish on detailed areas

Other materials

- 19mm x 38mm treated tile batten
- OSB3 decking board (2400x600x18mm T&G)
- 63mm paslode nails (all nails should be galvanised and at least 60mm long and should be ringshank nails, screw or better)
- 13mm galv felt nails (for fixing trims)
- Lead sealant (for sealing flashings into wall only)
- Decorators wipes
- Rubbish bags
- Slate granules

Other tools

- Strong shovel
- Wrecking bar
- Claw hammer
- Circular saw/jig saw
- Mastic gun
- 5" Grinder + stone blade for cutting trims
- Cure It Extension Pole
- Cure It Sanding Head
- 40 Grit aluminium oxide paper
- Soft and stiff sweeping brushes
- Visqueen ground sheet (in case of rain)
- Nail gun

Personal protection equipment

- Eyewash station
- Protective goggles
- Disposable gloves
- Suitable footwear
- Resin resistant overalls
- P3 Dust Mask
- Carbon filter mask (optional)

General information

Stages of installing a Cure It roof

The installation of a Cure It roof can be divided into 4 stages:



Preparing and decking the roof

(page 9)

The old roof covering is removed and the roof is re-decked with OSB3 18mm tongue and groove boards.



Fixing the edge trims

(page 10-13)

GRP edge trims are fixed to the perimeter of the roof and can be used to adapt the Cure It laminate to almost any application.



Laminating

(pages 13-15)

Joints between decking, gutters, GRP trims and protrusions e.g. pipes are bandaged at this point. The entire roof is then laminated with a layer of GRP.



Topcoating and finishing

(page 16)

The roof is then topcoated, with the client's specification of colour and finish.

Stage 1

Laying the deck

Preparing the deck

When laying decking, it is important to remember that the decking board will absorb moisture if in contact with water. Any moisture trapped within the roof will cause board movement, delamination and possibly failure. Ensure that conditions are dry before decking the roof. After removing the old decking, check that all roofing joists are sound and free from rot. Replace these as required. Any 'play' in the joists should be addressed at this stage. Re-bed loose joists or use noggins to ensure the joists are all stable. This is important to prevent issues with noise in the finished roof. Ensure all joist spans are less than 600mm. If possible, build a fall into the substrate so that the roof can drain completely and remain free from standing water.

FOR A WARM ROOF CONFIGURATION REFER TO THE GUIDANCE ON PAGE 24

Laying the deck

18mm OSB3 tongue and groove boards are laid at 90° to the roof joists. The boards must be laid with the gap side of the tongue and groove joint uppermost. Not only does this give a better key for the laminate, it also allows the resin to flow into the board joint to effectively glue the boards together.

Start to lay the boards at the furthest edge from the drip. If the board is laid along a wall, an expansion gap of 25mm should be left. Align the end of the board with the fascia, laying the boards from end to end. Trim the last board in the row flush with the fascia. Using the off-cut (if greater than 400mm,) start to lay the next row of boards by fitting the tongue firmly into the groove of the row already laid. Ensure each run of decking is staggered with at least a 400mm off-set between the joints in each row.

When two rows have been laid the boards can be aligned to run straight. Fix the boards to the joists using a ring shank nail or screw with 40mm joist penetration at 200mm centres. Continue to lay each row in turn using the off-cut from one row to start the next row. The last row is simply cut off in line with the fascia.

Fixing the deck to different substrates

IT IS ESSENTIAL THAT THE DECK IS LAID CORRECTLY

Timber

When fixing the OSB3 board to timber joists, the preferred method is with a nail gun. This is the most efficient way of fixing the decking; it also minimises damage to the ceiling below. A 63mm (or longer for a warm roof) galvanised ring shank nail should be fixed at 200mm centres, which equates to 4 nails across a 600mm board. The nails **MUST** be driven into a joist. Some installers may wish to use screw guns. This is acceptable providing the screws have a minimum of 40mm penetration into the joist. The boards can also be nailed using a hammer. This is obviously time consuming and **WILL** lead to internal damage of the ceiling. All nails must be non-rusting (galvanised or sheradised).

Steel

Fixing to steel is easily achieved with the use of self-drilling/self-tapping screws of the appropriate length.

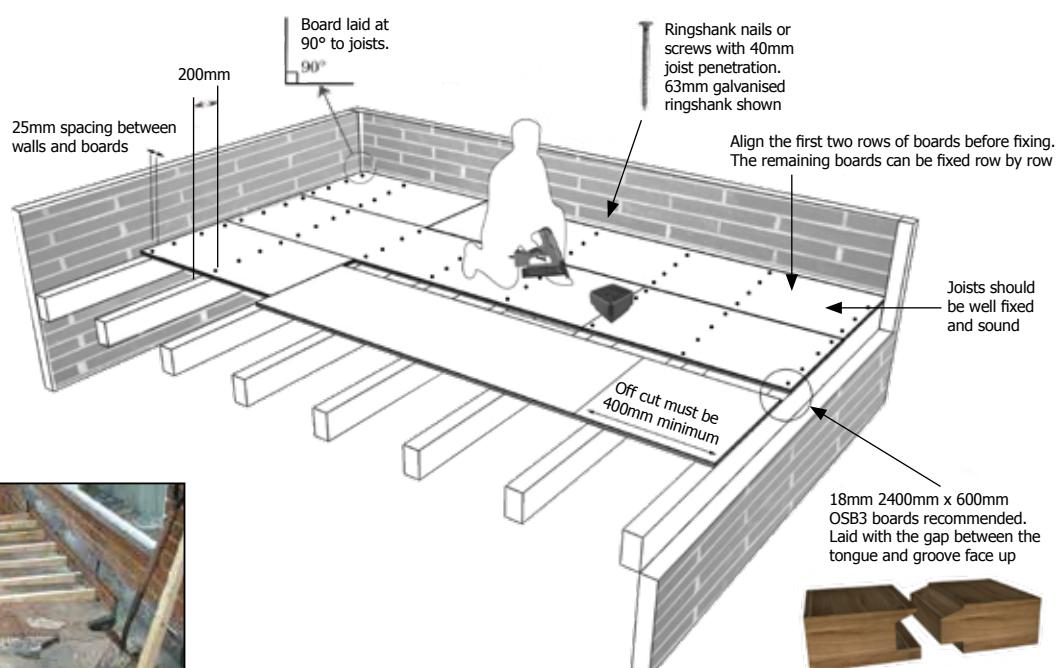

Firrings fixed to a flat roof to aid run-off

Stage 2

GRP edge trims

The following pages include instructions for fixing the most common types of GRP edge trims. For a comprehensive list of trim applications see the trim application pages of this manual. All trims are supplied in 3m lengths as standard with the exception of F300. Heavy duty trims are available by special order.

Edge trims are manufactured in GRP. One side has a high adhesion finish (matt finish), the other side has a glossy finish, always bond to the matt finish.

All trims must be fixed with nails or staples to the decking board.

With the exception of the F300 Flat flashing and the D260 Angle fillet, the trims must be bonded in place using the trim adhesive. Silicone sealant or general-purpose mastics are not suitable adhesives for the fixing of trims.

Cure It Trim Adhesive

Cure It Trim Adhesive is applied with a skeleton gun to the battens around the perimeter of the roof. A continuous bead is sufficient to hold the trims in place. The trims should be 'rubbed' into place to ensure good bonding.

Joining Trims

Trims are either nailed to the decking boards using a 13mm galvanised clout nail or stapled in place with a gas powered or compressed air stapler. Hold the trim in place ensuring the face is vertical. Drive fixings in at each end, then the middle and then at 100mm centres thereafter.

Most common trim types and application instructions:

A170/A200/A250 - Drip Trim

The A type trim is a drip trim, fitted to the lowest edge of the roof usually where the rainwater flows into the gutter. Two support battens should be fixed to the perimeter of the roof to provide space for the gutter to fit behind the trim, with the outer batten attached 10mm lower than the inner batten to allow the trim to sit flush with the roof. Apply adhesive to the batten in a continuous strip then rub the trim into place and nail to the decking. Do not nail through the front of the trim. If the pitch of the roof is only minimal, rainwater is likely to hold behind the trim. A planing machine can be used to take 2mm off the deck to allow the trim to lay flush with the board.

TRIM DETAILS: A170: This is designed for applications where it is not possible to use the larger A200. A200: This is the standard size drip trim. A250: This drip trim is ideally suited for use on warm roofs.

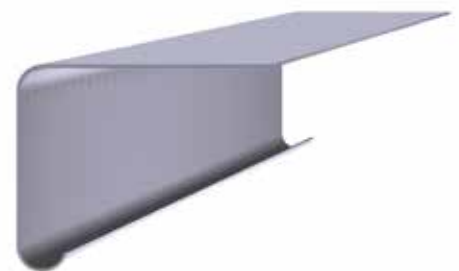

A170/200/250 Application diagrams:

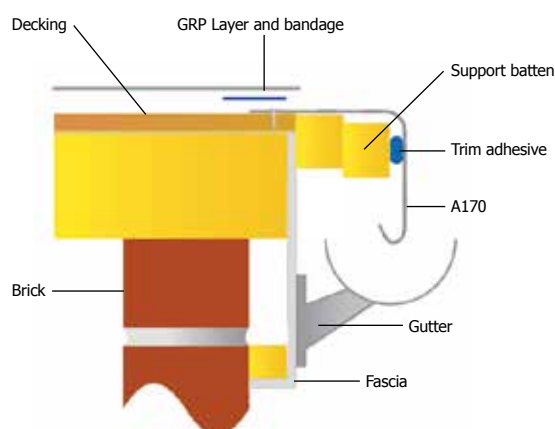

NOTE: If the fall of the roof is only slight, the end of the decking board should be planed by 2mm before the battens are attached, to allow the trim to sit flush with the rest of the roof.

Stage 2

GRP edge trims

B230/B260/B300 - Raised Edge Trim

A single batten is fixed level with the top edge of the deck. Apply the Cure It Trim Adhesive in a continuous strip along the batten, then rub the trim into place and nail through the top of the trim into the decking. Do not nail through the front of the trim. If a ladder is likely to be leant against a B type trim for regular access to the roof, the trim will need to be reinforced to avoid deformation. The trim can either be doubled up by slotting a section of extra trim within the section where the ladder will be used or it can be reinforced with an extra layer of Cure it laminate and then tissue to maintain a smooth finish. Alternately, a wooden batten can be shaped and fitted into the ridge of the trim to ensure that it remains rigid.

TRIM DETAILS: B230: The smallest size of raised edge trim fitted to the edges of the roof to contain and direct the flow of water. B260: The standard size raised edge trim. B300: Larger raised edge trim for use on warm roofs.

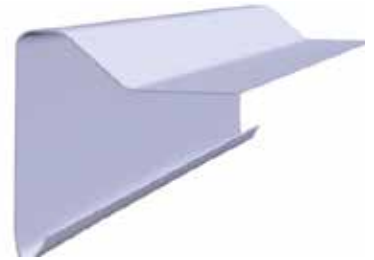

B230/260/300 Application diagrams

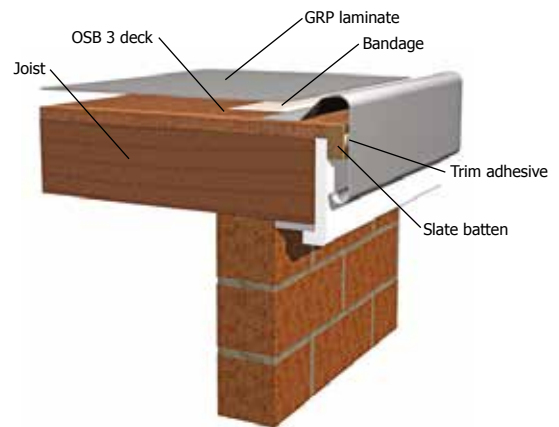
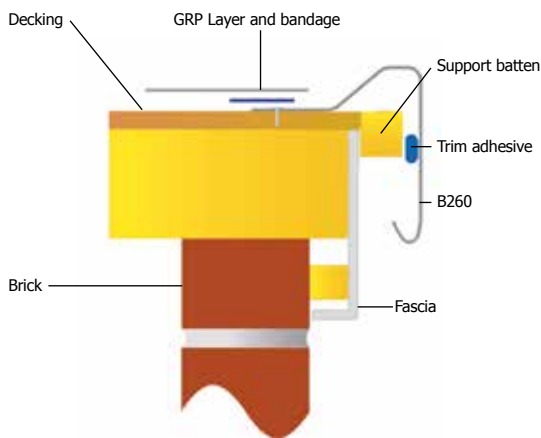

C100/C100MT/C100L/C100LMT/C150/C150MT/C150L- Simulated Lead Flashing

The C trim is usually fitted into a bed joint of the brickwork or a 35/50mm (depending on the trim type) deep chase cut out with an angle grinder fitted with a mortar chase disc. Apply the Cure It Trim Adhesive in a continuous strip to the back of the C trim. Fit the trim into the slot and press firmly back to the wall to overlap the D trim. Apply a lead sealant along the length of the trim into the slot to seal the trim in. Do not topcoat.

TRIM DETAILS: C100: Standard simulated lead flashing with 100mm vertical face and 35mm wall penetration. C100MT: As C100 with self securing moisture trap. C100L (Long leg): As C100 with 50mm wall penetration. C100LMT (Long leg with Moisture Trap): As C100 with 50mm wall penetration and self securing moisture trap. C150: Simulated lead flashing with 150mm vertical face and 35mm wall penetration. C150MT (Moisture Trap): As C150 with an integral, self-securing moisture trap. C150L (Long leg): As C150 with 50mm wall penetration.

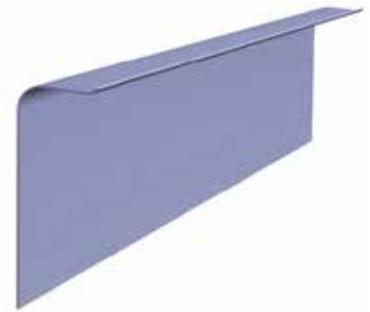

C100/C100MT/C100L/C100LMT/C150/C150L/C150MT/ Application diagrams

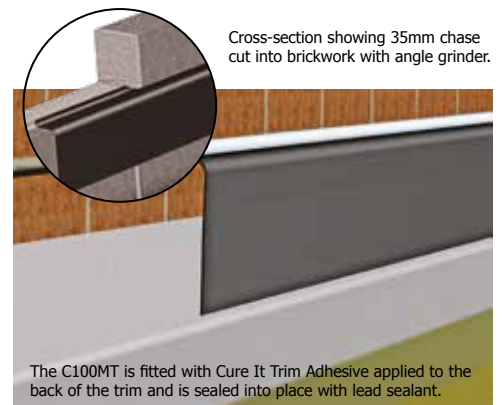
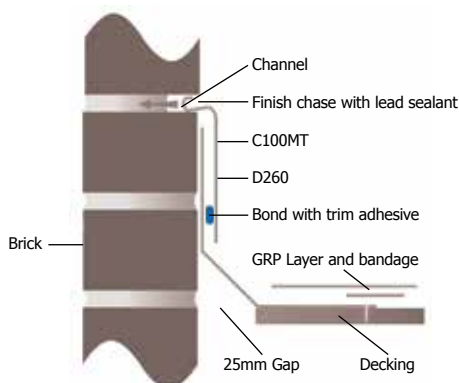

Stage 2

GRP edge trims

D260/D300 - Fillet Trim

The D trim is a fillet trim for use against abutting walls. It will also provide expansion and perimeter ventilation and is compatible with C2 left and right and C3 internal and external corners. Place the D trim against the vertical face and push down diagonally into the corner until the trim fits snugly. Where the D trim needs to be joined it should be overlapped and bonded with adhesive and bandaged together.

TRIM DETAILS: D260: Angle fillet trim with 135 and 70mm trim flanges. D300: Angle fillet trim with 175mm and 70mm flanges.



D260/D300 Application Diagrams

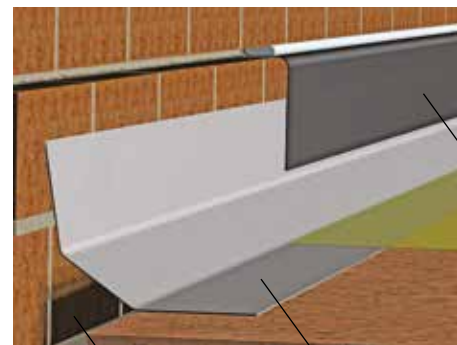
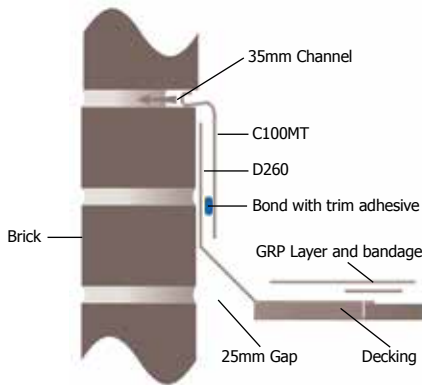

The D trim remains unattached behind the C100.

25mm gap to allow for expansion of the decking.

The D trim is pushed right up to the wall before being fixed to the deck and not the wall.

F150/F300/600/900 - Flat Sheeting

The F trim is a flat flashing, which can be used as a layboard at the intersection of a pitched roof and flat roof often found on dormers and to fabricate gutters in situ. The F trim should not be laminated over completely as it may crack. It is nailed or stapled to the deck and bent up the roof slope. In this situation, the F trim also acts as an expansion facility and must only be fixed to the deck along the bottom edge. There are many other applications for the F trim including vertical details where laminating would be time consuming, under the feet of air conditioning units to enable re-roofing without disconnecting and use on some parapet wall details etc. The trim should be nailed to the deck around its edges and bandaged over any joints or nail penetrations. Any unlaminated trim can be topcoated with the rest of the roof. Laminate onto the mat side only.

TRIM DETAILS: F150/F300/600/900: Flat sheeting supplied in 150, 300, 600 and 900mm widths in 20M rolls. F300 Also available in 3M + 10M rolls.



F300/600/900 Application diagrams

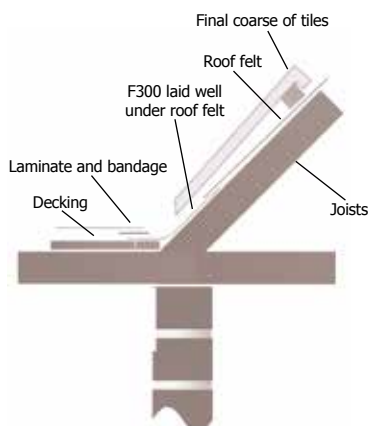

AT195 Internal and External

The AT195 Internal and External trims are used wherever the laminate needs to cover an area which needs to continue at another laminated surface. The AT195 Ext is supplied with a high-adhesion finish on its inner fascia and should be used for capping applications. The AT195 Int trim is supplied with a high adhesion finish on its outer fascia and should be used for internal corners, step applications or in gulleys*. The trim should be nailed at both edges if possible. Always bandage over the join between where the nails penetrate the trim and the decking before applying the laminate.

TRIM DETAILS: AT195 Ext: External angle trim. AT195 Int: Internal angle trim.

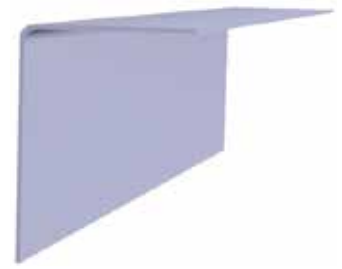

D260/D300 Application Diagrams

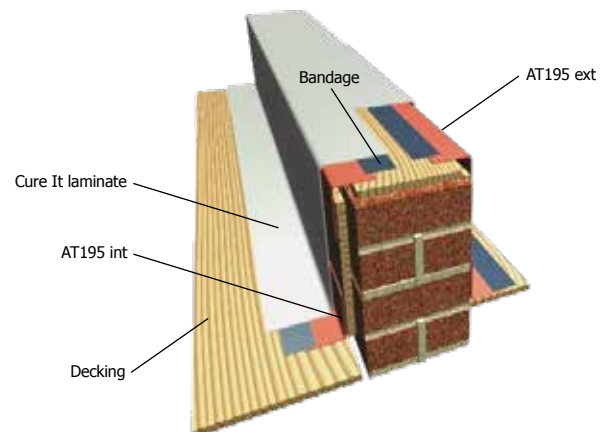
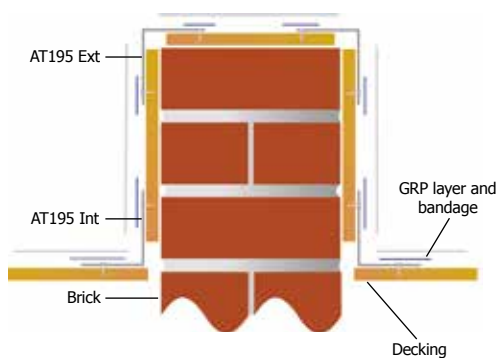

SEE THE TRIM APPLICATION SECTION ON PAGES 26 FOR FURTHER GUIDANCE

Cure It Reinforcement Mat

Before the reinforcement mat is laid out, the deck must be clean and dry and all the trims fixed in place. The mat has a cut edge and a feathered edge. Always overlap the feathered edge on top of the cut edge.

The mat is usually best laid parallel to the drip trim. Start by rolling the mat out, overlapping the trim by at least 50mm but not over the edge of the trim. Leave the ends long at this stage. Roll out each 1m wide strip overlapping each time by at least 50mm right across the roof. The ends can be cut off with a Stanley knife into the corner of the trim to leave a straight and neat edge.

Decide on the best place to finish laminating the roof from. Roll the mat up to the furthest point from the ladder. Leave the rolls on the roof where they have been laid out to avoid any mix up if there is a deviation in size or angle from one length of mat to another.

Corners and joints

Cut 200mm squares of mat for each corner and 200mm strips of bandage for each trim joint.

Laminating the roof

Cure It Roofing Resin

Cure It Roofing Resin is supplied in tins of 20kg (for ease of mixing, simply use the measurements on the Cure It Mixing Bucket). The Cure It Mixing Buckets are graduated in kilos which will allow easy calculation of the amount of hardener needed depending on the ambient temperature. Hardener must be added to all resin and topcoat in order for it to cure.

Remove the lid from the can using a long screwdriver to bend back all of the lugs on the lid. It is very important to stir the resin in the can before use, ensuring the additives that have separated get thoroughly mixed in.

It is good practice to mix a small quantity of resin (1 or 2 kilos) to start with to laminate the corners and bandage the trims. This will give the best indication of the curing time of the resin and confirm if the correct amount of hardener has been added to the mix. Always use a hardener dispenser, it is best to aim for a curing time of between 20 to 30 minutes. Refer to the Cure It Mixing Bucket for guidance on adding hardener or refer to the hardener addition chart on page 17.

Techniques: If a laminate of GRP requires a perfect finish, i.e. it is somewhere likely to be frequently overlooked such as a balcony, join lines between reinforcement mat rolls can be avoided by feathering the reinforcement mat. This is achieved by roughly ripping a small strip off the cut end of the reinforcement mat. When this is laid on top of another feathered roll, the join will be seamless.

*A D260 should always be used for areas with parapet walls or abutting walls to allow for expansion.

Stage 3

Laminating

Laminating

Corners and bandaging

Lay a 200mm square piece of mat on the roof deck and 'wet out' on both sides with resin (see hardener addition chart) using a 70mm application roller. Place the mat onto the face of the adjoining trims with the bottom edge on the radius of the trim. Fold around the corner and fold over the top of the trim down on to the deck. It will be easier to dress and feather if the mat is cut vertically from the top corner of the trim upwards. Using the 70mm roller, 50mm laminating brush and small consolidator roller, feather the corners into place. Any joint in the trims should be bandaged using the same mix of resin. If any boards are not completely engaged these joins should be bandaged, even a small gap may cause resin to leak through the boards which will lead to porosity in the laminate.

If any nails holding the trims are not going to be covered with laminate on the deck or corners they should be laminated with a small piece of mat. The deck of the roof can be laminated before the corners and bandages have cured.

Bandaging for all other details can be completed as outlined in the GRP Edge Trim section.

Laying the main laminate

Unroll 1m of previously cut mat along the lowest part of the roof and align so it can be unrolled across the roof without running off-line. Carefully roll the mat back.

YOU MUST FOLLOW THESE INSTRUCTIONS TO GAIN THE CORRECT RATIO OF RESIN TO GLASS.

To get a ratio of 3:1 one-third Cure It Roofing Resin (with hardener added) should be applied on the board and two thirds resin and hardener on the mat dip the 140mm application roller into the bucket of resin. Lift the roller out of the bucket and without letting the excess run off, drop 3 rollers full onto the board and coat 1 square metre. This will ensure that there is a ratio of one-third resin on the board.

Unroll the mat onto the Cure It Roofing Resin coated board. In strips of 140mm (1 roller width) wet out the mat by dropping 1 roller full in the middle of each 140mm run, push the roller away to the end of the 1 metre run, then pull back over the full 1 metre (figure 4.)

Continue across the 1m² (approximately 6 runs) and then roll the roller over the whole area again to ensure good even coverage.

Wet out the next 1m² of board in the same way, remembering to use one third of the Cure It Roofing Resin on the board and two thirds of resin on the mat. Roll out the mat over the next 1m² of wet out board and continue to roll out the Cure It Roofing Resin as previously described.



Any other protrusions such as pipes, skylights or other potential weakspots should also be laminated around/over at this point.
Any joints between trim lengths are bandaged over.



A polyester roller is used to apply the resin to the Reinforcement Mat.
Cure It Roofing Resin is applied to the deck before the Reinforcement Mat is laid on the roof.



After the Reinforcement Mat has 'wet out', the consolidator roller is used to expel air from the laminate and ensure the Reinforcement Mat has been saturated by the resin. No white patches should be visible.
As the Reinforcement Mat absorbs the resin, the laminate becomes transparent.

Note:

- Never attempt to lay a roof in wet weather or when wet weather is forecast.
- If it starts to rain while you are laying a roof, the roof must be covered and must not get wet, always keep a large visqueen sheet on site to cover the roof. The visqueen will not bond to the curing laminate
- If rain is forecast while laying boards, the boards can be temporarily sealed with a coating of resin. Always ensure that as much of the roof is covered as possible, ensure that edges, or areas of possible water ingress are covered.
- If decking has become damp, do not attempt to lay laminate on top.
- Always ensure that the surface you are laying onto is completely dry and free from debris before you start. A wet surface can lead to delamination

Stage 3

Laminating



Figure 4.

Consolidating

Let the Cure It Roofing Resin soak into the mat to break down the binder for 2 to 3 minutes. Using the paddle roller and applying a little pressure, roll back and forth along the 2 edges and the end of the wet mat. Now roll the paddle roller over the whole of the wet out mat, ensuring the paddle roller makes at least 2 passes over the whole area. In colder weather the resin will be thicker and will take a little longer to wet out. When a laminate is correctly wet out it should be transparent, there should be no white or opaque areas. Take care near the edge of the roof and in windy conditions as a fine spray will be emitted from the roller.

Make regular close inspections of the laminate as it is consolidated, checking for 'pinholes' and areas short of Cure It roofing Resin. Pinholes in the laminate will lead to porosity and water penetration. While completing the next metre wide run of laminate, put a quick 'wash coat' of the resin (1 roller full per 2m²) over the previous run of finished laminate.

On all overlaps of the mat, pay extra attention to the 'feathering in' as this will improve the overall appearance of the finished roof.

Preparation for topcoating

Taking care and paying attention at this stage will produce a roof of superb appearance. Using a Cure It sanding pad with a 40 grit sand paper, lightly sand the corners and trim bandages. Sand off any unsightly fibres, taking care not to sand too heavily on the corner itself as this may lead to holes appearing. Cut any excess cured mat protruding beyond the trim with a sharp Stanley knife.

Seal any abutments with walls using a clear silicone sealant. Fit any C100 simulated lead flashing before top coating and seal off the chase with a clear silicone sealant or Cure It Trim Adhesive. Occasionally mortar will be required to finish the chase.

Premium cost options:

When a client specifies a Cure It roof there are a number of different options available for the weight, colour and finish of the roof. All of these should be charged at a premium.

- The Cure It laminate can be specified in two weights: 450g/m² and 600g/m². 450g/m² is the standard weight for most installations and will withstand foot traffic. 600g/m² should be specified where the roof will be subject to regular heavy foot traffic such as a walkway or balcony. This would normally be specified with an aggregate slip resistant finish.
- The roof can be finished in any BS4800 colour.
- The roof can be finished with a standard smooth or two choices of non-slip finish (see next page.)

Stage 4

Topcoating and Finishing

Topcoating the roof

The Topcoat is a resin and should be treated in the same way as the base resin. It requires the addition of hardener for it to cure.

Always try to apply the topcoat immediately after the laminate is semi-cured (can be walked on, no stickiness) If this is not possible then ensure topcoating is carried out within 24 hours to gain good bonding with the laminate. If the topcoating is left longer than 24 hours then wipe down the laminate with acetone to gain a good bond of the topcoat to the laminate.

Remove the lid and stir the topcoat well before use. Ensure the styrene and wax at the bottom of the tin is fully mixed in. Pour out into the mixing buckets enough topcoat to cover the perimeter of the roof (including the edge trims.) Use a 70mm application roller to coat the trims. A roller will get a better and more even finish than a paintbrush. Roll the topcoat along the face of the trim. Hold the roller at an angle to the bottom of the trim to cover half of the radius return on the front of the trim. To protect the fascia from topcoat, hold a piece of flashing trim behind it as you topcoat the radius on the underside of the trim.

Calculate how much topcoat you will need to use to cover the main body of the roof. Add the required amount of hardener and stir well.

Using the 140mm application roller, cover the remaining laminate with just enough topcoat for the fibre pattern to be visible. Do not coat the roof too thickly or the topcoat will crack. If a coloured topcoat is needed rather than the standard graphite grey, a colour pigment will need to be added to a clear topcoat. A 20kg tin of topcoat requires 2kg of colour pigment. It is essential to mix the pigment thoroughly into the topcoat to avoid patchiness and uneven colour.

Cleaning Tools and Equipment

Buckets can be re-used for many jobs. When hardener is added to each mix, coat the entire inside of the bucket. When the resin has cured after approximately 30 minutes it can be peeled out, leaving the bucket like new and ready for the next job.

Paintbrushes can be dropped into a re-sealable container of acetone and left for the next job. Use only paintbrushes that have unpainted or uncoated handles, as the coatings will come off and contaminate the resin. Application rollers have sleeves that are removable. It is too time consuming to clean the roller sleeves. Unscrew the nut with pliers and drop the used sleeve into the bucket of used resin.

Either use disposable latex gloves when handling hardener or resins or clean hands with hand cleaner. Do not clean hands with acetone. Wipes are also a useful addition to your toolkit. As well as cleaning hands they are good for removing uncured resin splashes from windows and fascias.

DO NOT LEAVE ACETONE IN OPEN CONTAINERS. IT IS HIGHLY FLAMMABLE

Slip Resistant Finishes:

Slate Granules can be used with Cure It Topcoat to achieve an Exposed Aggregate or Coated Aggregate finish (Coated with Topcoat).

For the best finished appearance avoid coating the perimeter of the roof and the trims with aggregate, and retain a smooth finish. To achieve this, the trims should be topcoated before the granulated slate is applied, along with the first 100mm of the roof inbound of the edge. When the topcoat has cured, use 50mm masking tape to neatly mask off the topcoated area of the roof, and then follow the instructions below for the required finish:

Exposed Aggregate

Apply the topcoat to the roof in metre wide strips starting away from the access point at the usual rate of 0.4kg/m². After the first metre run, sprinkle the granulated slate over the topcoat using 0.75kg/m² allowing a 200mm border adjacent to the un-topcoated area of the roof. The border will prevent the next run of topcoat being applied onto the roof from becoming contaminated by the slate granules. Continue to apply topcoat to the next metre strip and apply the granules to cover the previous border and leave another 200mm border on the next strip. Repeat with subsequent runs working towards the access point.

Curing time will vary. This can take at least 20-30 minutes in warmer weather and may be an hour or longer in colder conditions. Ensure that the topcoat has completely cured before sweeping the excess granules together and collecting the excess in a bag or bucket to use on the next job. Remove the masking tape from the perimeter. (See pic on page 6).

Coated Aggregate

Apply the topcoat to the roof in metre wide strips starting away from the access point at the usual rate of 0.4kg/m². After the first run sprinkle the granules over the area at a rate of 0.15kg/m². Roll the granules into the run of topcoat with the application roller.

Repeat this process for subsequent runs to complete the roof. The granules will cure into the topcoat. Remove the masking tape from the perimeter of the roof once the roof has cured.

Hardener addition

	SUMMER/EXTRA SLOW HARDENER	SUMMER HARDENER	WINTER/SUMMER HARDENER	WINTER HARDENER
Deck/Resin temp	22-35°C	18-22°C	12-17°C	0-11°C
Percentage Hardener	1% Hardener	2% Hardener	3% Hardener	4% Hardener
Table of Percentages in Millilitres, Per Weight of Resin Used				
Amount of Resin	Hardener Usage			
1 Kilo	10 ml	20 ml	30 ml	40 ml
2 Kilo	20 ml	40 ml	60 ml	80 ml
3 Kilo	30 ml	60 ml	90 ml	120 ml
4 Kilo	40 ml	80 ml	120 ml	160 ml
5 Kilo	50 ml	100 ml	150 ml	200 ml
6 Kilo	60 ml	120 ml	180 ml	240 ml
7 Kilo	70 ml	140 ml	210 ml	280 ml
8 Kilo	80 ml	160 ml	240 ml	320 ml
9 Kilo	90 ml	180 ml	270 ml	360 ml
10 Kilo	100 ml	200 ml	300 ml	400 ml
11 Kilo	110 ml	220 ml	330 ml	440 ml
12 Kilo	120 ml	240 ml	360 ml	480 ml
13 Kilo	130 ml	260 ml	390 ml	520 ml
14 Kilo	140 ml	280 ml	420 ml	580 ml
15 Kilo	150 ml	300 ml	450 ml	600 ml
16 Kilo	160 ml	320 ml	480 ml	640 ml
17 Kilo	170 ml	340 ml	510 ml	680 ml
18 Kilo	180 ml	360 ml	540 ml	720 ml
19 Kilo	190 ml	380 ml	570 ml	760 ml
20 Kilo	200 ml	400 ml	600 ml	800 ml

Hardener Addition

There are a number of important rules of thumb to follow when deciding how much hardener to add:

- Never use less than 1% even in the summer, just mix less resin at a time.
- Never use more than 4%, the gel time will not reduce any further beyond 4%.
- Never underestimate the effect of temperature. Resins will not cure at or below freezing and will always cure much quicker in direct sunlight.
- When topcoating late in the day, add more hardener to allow for the lack of sunlight.
- In cold weather use winter hardener, in warm weather use summer hardener, in very hot conditions use slow hardener.
- Remember: Any hardened resin left in the bucket will exotherm. Heat is generated as the resin cures, so it should be kept well away from other stored materials. Water can be poured over the resin to suppress the heat gain.
- Always mix the hardener into the resin thoroughly before using the resin (i.e. a good couple of minutes for a 10 litre bucket.) Failure to do this can result in 'streaking' on the laminate, where streaks of uncured resin will remain visible and ultimately lead to a failure in the laminate.
- Fast cures can result in an inadequate bond.

Ready reckoner

Cure It materials estimation chart

This guide is an approximation of the quantities of materials required when laying a GRP roof. It should be noted that these values are not an accurate representation of the materials that will be needed for all GRP roofs of these sizes, detail and complex surfaces will adversely affect these values. The materials in the top table are required for every installation, many of the materials in the lower table can be reused. GRP Edge Trims are not shown. Always use a hardener safety dispenser.

Roof Size (M ²)	Cure It Resin		Cure It Topcoat		Cure It Reinforcement Mat		Hardener		Bandage - 1 roll = 75m	OSB3 (8'X2') Inc. 5% waste	Cure It Trim Adhesive
	Kg	cans required	Kg	cans required	Kg	rolls required	(1% - 4% Maximum)	bottles required			
5	8	1 x 10kg	2	1 x 5kg	2.5	6.6kg	100ml - 400ml	1 x 1kg	1	4	1
10	18	12m kit	4	12m kit	6	12m kit	12m kit	12m kit	12m kit	9	12m Kit
15	25	1 x 10kg 1 x 20kg	6	1 x 10kg	7.5	16.5kg	300ml - 1200ml	2 x 1kg	1	11	1
20	35	2 x 20kg	8	1 x 10kg	10	16.5kg	400ml - 1600ml	2 x 1kg	1	15	2
25	42.5	1 x 10kg 2 x 20kg	10	1 x 10kg	12.5	16.5kg	500ml - 2000ml	2 x 1kg	1	19	2
30	50	1 x 10kg 2 x 20kg	12	1 x 5kg 1 x 10kg	15	16.5kg	600ml - 2400ml	3 x 1kg	1	22	2
35	57.5	3 x 20kg	14	1 x 5kg 1 x 10kg	17.5	16.5kg & 6.6kg	700ml - 2800ml	3 x 1kg	1	26	2
40	65	1 x 10kg 3 x 20kg	16	1 x 20kg	20	16.5kg & 6.6kg	800ml - 3200ml	4 x 1kg	1	30	3
45	72.5	4 x 20kg	18	1 x 20kg	22.5	33kg	900ml - 3600ml	4 x 1kg	1	34	3
50	80	4 x 20kg	20	1 x 20kg	25	33kg	1000ml - 4000ml	4 x 1kg	1	37	3
55	87.5	1 x 10kg 4 x 20kg	22	1 x 5kg 1 x 20kg	27.5	33kg	1100ml - 4400ml	1 x 5kg	1	41	4
60	95	5 x 20kg	24	1 x 5kg 1 x 20kg	30	33kg	1200ml - 4800ml	1 x 5kg	2	44	5
65	102.5	1 x 10kg 5 x 20kg	26	1 x 10kg 1 x 20kg	32.5	33kg	1300ml - 5200ml	1 x 1kg 1 x 5kg	2	48	5
70	110	1 x 10kg 5 x 20kg	28	1 x 10kg 1 x 20kg	35	33kg & 6.6kg	1400ml - 5600ml	1 x 1kg 1 x 5kg	2	52	5
75	117.5	6 x 20kg	30	1 x 10kg 1 x 20kg	37.5	33kg & 6.6kg	1500ml - 6000ml	1 x 1kg 1 x 5kg	2	55	6
80	125	1 x 10kg 6 x 20kg	32	2 x 20kg	40	33kg & 16.5kg	1600ml - 6400ml	2 x 1kg 1 x 5kg	2	59	6
85	132.5	7 x 20kg	34	2 x 20kg	42.5	33kg & 16.5kg	1700ml - 6800ml	2 x 1kg 1 x 5kg	2	62	6
90	140	7 x 20kg	36	2 x 20kg	45	33kg & 16.5kg	1800ml - 7200ml	3 x 1kg 1 x 5kg	2	66	7
95	147.5	1 x 10kg 7 x 20kg	38	2 x 20kg	47.5	33kg & 16.5kg	1900ml - 7600ml	3 x 1kg 1 x 5kg	2	70	7
100	155	8 x 20kg	40	2 x 20kg	50	2 x 33kg	2000ml - 8000ml	3 x 1kg 1 x 5kg	2	73	7

Roof Size (M ²)	70mm Soft Roller	140mm Soft Roller	Small paddle	Large paddle	Brushes (25mm - 100mm)	Acetone (Litres)	Gloves (Box)	Finishing Tissue 150mm - 25m roll	Hardener Dispenser	Cure It Mixing Bucket
5'	2	2	1	1	2	1	1	1	1	2
10'	2	4	1	1	2	3	1	1	1	2
25	4	6	1	1	4	5	1	1	1	3
50	4	8	1	1	4	5	2	1	1	4
75	6	10	1	2	6	10	2	1	1	5
100	8	12	1	2	6	10	3	1	1	5
200	12	20	3	4	10	15	5	1	1	5

Edge trims and corners will also be required. Training recommended before use. 'Cure It Accessory Starter Pack contains ancillary items that can be used up to 10m² roof size.

General advice when laying a Cure It roof

Repairing a Cure it roof

If the roof surface becomes damaged by impact or has to be cut for any reason it can be easily repaired using the following procedure:

1. Wipe off the damaged area with acetone and lightly abrade the GRP surface with a hand grinder for a distance of 100mm from the damaged area or edge to be joined.
2. Cut the 450/600gm² glass to 200mm extra than required to cover the affected area and rip the edges for a feathered finish.
3. Mix sufficient resin with hardener as previously described. Brush resin onto the area to be laminated at the rate of 0.5kg/m².
4. Place the glass over the area, wet out the glass with resin at the rate of 0.5kg/m². Stipple well with the brush or use a paddle metal roller for larger areas.
5. Ensure that the laminate is free from air and completely consolidated and allow to cure.
6. Mix the Topcoat with hardener as previously described and apply with a brush at the rate of 0.4kg/m².
7. Allow to cure.

This procedure will ensure that the patch or joining piece applied will bond to the original laminate and form a weatherproof patch over the damaged or cut laminate.

Advice when using Cure It during Winter months

- Always check the local weather forecast.
- During the Winter, avoid topcoating a roof after 2-3pm unless it is a clear bright day and not too cold. The heat from the sun contributes a great deal towards the curing of the laminate during colder months. After the sun has set, it is unlikely that the topcoat will cure over night. If left uncured, the topcoat may cure with debris and leaves stuck to the surface, or with an undesirable finish if it rains.
- Ensure that the surface temperature of the boards is checked before laying the Cure It Roofing Resin or Topcoat. (can use infrared thermometer)
- Ensure that the Cure It Roofing Resin is kept warm before use if the ambient temperature is below 10°C.
- Always ensure that the Cure It Roofing Resin remains indoors in a warm place the night before it is used.
- Do not use Cure It Roofing Resin or Topcoat in temperatures below 5°C.*
- If it begins to rain, cover the roof with a visqueen sheet.
- If you are unable to laminate over a prepared deck, then coat the decking with hardener mixed with Cure It Roofing Resin and cover any exposed edges. This will seal the deck and prevent moisture uptake until the laminate can be applied. Always cover the edges of the roof and uncoated boards with a polyethylene sheet.
- Always ensure the deck or substrate to be laid onto is completely dry before laying the laminate. Sweep off any excess water and mop up the excess with dry cloths before allowing the roof to dry naturally. Wiping the surface with acetone can speed up this process.
- Do not start to lay a roof if a period of rain is forecast.

Advice when using Cure It during Summer months

- Always check the local weather forecast.
- Do not use Cure It Roofing Resin or Topcoat in temperatures above 35°C.
- Always mix smaller batches of Cure It Roofing Resin than you normally would to give adequate time to apply it before it starts to catalyse.
- Always use extra slow hardener in hotter weather if the Cure It Roofing Resin starts to cure too quickly.
- Always apply the laminate in the shortest runs possible across a roof. The shorter the length of laminate, the less likely it is that the Cure It Roofing Resin will catalyse before it can be consolidated into the laminate.
- Use a temperature sensor to measure the surface temperature of the laminate before applying the topcoat. On surfaces that are too hot, the wax component of the topcoat will melt and the topcoat may remain tacky to the touch, this will usually mean that any loose debris will stick to the roof and the colour of the topcoat will also be impaired.
- If possible, topcoat the roof out of direct sunlight or wait until later in the day before applying it, this may mean that the roof will take you longer but it will save you time spent returning to the roof to re-topcoat it at a later date.

Safe working practices

It is always the installer's responsibility to ensure safe working practices for themselves and their employees and always pay attention to the risks for other members of the public that may be nearby at the time. Installers should always assess any potential risks when working on a contract and make sufficient means to address them. In addition to these notes, the installer should also be aware of the health and safety information that applies to most materials (see the relevant material safety data sheet for further information).

**If the temperature is below 5°C, use extra cold resin and topcoat. This can be used between 0°C - 10°C.*

Troubleshooting guide

Problems that occur while laying the roof

1) Failure of Cure It Roofing Resin to Harden

Description of problem - Laminate is still wet and resin is uncured with no other symptoms.

Possible cause

- Cure It Roofing Resin may have been inadequately mixed.
- Unsuitable hardener may have been used (e.g. Extra slow or summer hardener used in winter.)
- Not enough hardener may have been used for the temperature.

Remedial action

- Add Hardener to another batch of resin, ensuring that you use the correct hardener. Always add extra hardener (doubling up if necessary but not exceeding 4%) and roll vigorously into the uncatalysed resin.
- Larger laminates or laminates that have been left for a long time or contaminated by dirt, debris or water etc. may need replacing completely.
- Always check the ambient temperature before mixing batches of resin and consult the hardener chart for guidance if unsure.

2) Cure It Roofing Resin cures too fast

Description of problem - Cure It Roofing Resin cures before it can be properly applied and consolidated into the Reinforcement Mat.

Possible cause

- Unsuitable hardener may have been used (e.g. Winter hardener used in Summer.)
- Weather may be too hot for Summer hardener.

Remedial action

- If the ambient temperature is very hot extra slow hardener
- Reduce the size of the batches mixed.
- Always ensure that you are laying the shortest possible runs across a roof to give you adequate time to properly consolidate the laminate.

3) It begins to rain while laminating/topcoating

Description of problem - Roof has not yet cured and it begins to rain.

Possible cause

N/A

Remedial action

- STOP! Cover the roof with a non-woven polyethylene sheet and try to ensure that none of the laminate gets any moisture onto it.
- Always ensure that you check the local weather forecast before you start a roof.
- Always have enough polyethylene sheets with you to cover the roof. Resin contaminated with water will not cure and require a re-skin (see below.) Continue when the weather and surfaces are completely dry. Check for water contamination (below).

4) Water contamination (white staining of laminate)

Description of problem - Water contaminated resin usually appears as a white staining or milkiness. The resin will not fully cure.

Possible cause

- Cure It Roofing Resin has been contaminated by water, either from wet board or rain.

Remedial action

- Any white areas should be laminated over fully with a 450g/m² laminate - ensure the area is completely dry before sanding with 40 grit sandpaper and wiping with acetone. Re laminate with 100mm overlap of unaffected area.

5) Streaky laminate/topcoat

Description of problem - Laminate has partially cured, but has streaks of wet resin or lighter/darker colours running through it.

Possible cause

- Cure It Roofing Resin may have been inadequately mixed.
- Pigment may not have been mixed in thoroughly.
- May be contaminated by water.

Remedial action

- Always ensure that topcoat is applied thinly (0.5mm.) This makes it possible to reapply another layer of either properly hardened or thoroughly mixed, pigmented topcoat. If using pigment or hardener, add more to the second coat.

Troubleshooting guide

Problems that occur while laying the roof

6) Failure of topcoat to cure

Description of problem - Topcoat is still wet and has not cured.

Possible cause

- Topcoat has been used with unsuitable hardener (i.e. Summer hardener in winter.)
- Topcoat has not been sufficiently mixed or not enough hardener has been mixed in.
- Topcoat might be contaminated by water.

Remedial action

- After water has evaporated apply another very thin layer of topcoat, ensuring that it is vigorously and thoroughly rolled in to the uncured layer.
- Always add more hardener to the second batch, up to double if necessary.

7) Entrapment of debris in laminate

Description of problem - Debris entrapped in the laminate, possibly poking through the laminate, holes in laminate.

Possible cause

N/A

Remedial action

- This is usually seen while consolidating. The debris needs to be removed and patched over. This can be done while the laminate is still wet and then patched up with a new section of laminate.
- When the laminate has cured, the surface can be lightly rubbed with a coarse sand-paper. This will highlight any imperfections. The affected area must then be patched with a new laminate. If the debris is causing a significant lump it should be ground down with an angle grinder first.

8) Spillages

Description of problem - Spillage/resin spray.

Possible cause

N/A

Remedial action

- Resins stick by mechanical adhesion; they soak into a surface and cure. It is essential to clean the resin off the surface before it cures.
- The solvent for uncured resin is acetone. This can be used to remove resin from most surfaces including clothing (WARNING: acetone is extremely flammable.)
- If used to clean paintwork or coloured fabrics it may discolour or remove paint or dye from the surface.
- Resins will generally not adhere to anything that has a shiny surface. If resin has cured onto a surface such as glass, metal or paintwork, it may be flicked off using a sharp edge or by vigorously rubbing with a coarse cloth. The cleaned surface may then be buffed with wax polish or a cutting compound.
- With larger spillages (e.g. driveways or walls,) a hot pressure washer is the best choice, but high pressures will be required and strong detergents are usually necessary. Be aware that strong detergents and hot pressure washes can damage surface.
- Preventative measures are essential to avoid spillages.
- Always mask off adjacent areas where fine spray droplets, caused by the consolidator roller, may fall. Polythene sheeting is the best material for masking.

Troubleshooting guide

Problems that occur after the roof has been laid

1) Delamination of the laminate from the boards

Description of problem - Laminate is raised and springy.

Possible cause

- This is caused by poor adhesion of the laminate to the boards and is more likely to happen with plywood rather than OSB.
- Possible indicator of water contamination.

Remedial action

- The laminate can be completely removed and reapplied after priming the boards with G4 (to ensure no further delamination occurs).
- Fixings can be used to secure the laminate. Fixings are then bandaged over the roof. The roof is not leaking and there is no contamination with water.

2) Delamination of topcoat

Description of problem - This will not cause the roof to leak in most cases, but will spoil its appearance.

Possible cause

- Application of the topcoat to a contaminated surface (usually wet).
- Application of the topcoat to a hot laminate may also cause this to happen.
- Whenever the adhesion of the topcoat is poor, some topcoat delamination may occur.

Remedial action

- The topcoat cannot just be reapplied on top of existing topcoat.
- Generally, the best solution is to clean and abrade the surface, removing all of the flaking top coat, then wipe with acetone coat and re-laminate the entire roof surface and reapply the top coat.

3) Cracking of the topcoat

Description of problem - Cracks may appear as fine lines on the substrate. This will not cause the roof to leak in most cases.

Possible cause

- This is usually caused by the topcoat being applied too thickly, topcoat should never be applied thicker than 0.5mm.

Remedial action

- The only solution is to relaminate over the cracked area after thoroughly sanding affected area and cleaning with acetone.
- Area should be sanded to remove topcoat, wiped with acetone, coated with resin, mixed with hardener (0.25m²) then re-topcoated.

4) Cracking of laminate

Description of problem - Could cause the roof to fail if cracking is severe enough.

Possible cause

- The roof is over 100m² and an expansion joint has not been incorporated into the roof.
- Impact.
- Structural Movement.

Remedial action

- Grind down and laminate over the crack with two layers of 450g/m² reinforcement mat.
- It may be necessary to cut out a section and laminate and incorporate an expansion joint at 100m² intervals.
- Always check the board fixings, these may need to be re-fixed if they have been pulled away from the joists.

5) Ponding/standing water

Description of problem - A common problem and one which will not affect the performance of the roof but can be unsightly when a roof is overlooked, or, worse still, if it occurs on a balcony.

Possible cause

- The roof has been installed with an inadequate fall.
- The decking has not been rebated where A-trims have been attached causing a lip which holds water back.

Remedial action

- The best solution is to ensure that the original quotation confirms that the roof may be subject to ponding, and unless specified, it is difficult to guarantee that this will not occur.
- It is often not possible to improve the fall through the use of decking boards with help to disguise the water.

Troubleshooting guide

Problems that occur after the roof has been laid

6) Board swelling ('tile' outline on the roof)

Description of problem - This will cause a 'tile' effect to appear on the roof as the outlines of the boards appear as ridges on the roofs surface. The roof is unlikely to leak, but in very bad cases, some cracking may occur at the joints.

Possible cause

- This is caused by moisture uptake in the boards. It may be due to excessive condensation, but is more likely to be a result of some porosity in the laminate, allowing water to seep into the boards.
- The problem is made worse by poor board fixing, allowing the boards to move and rise up off the roof timbers.
- Insufficient expansion gaps have been left between the boards if over 100m².
- May cause ponding (see above.)

Remedial action

- The roof must be cleaned and all of the ridges ground down.
- New expansion joints must be fitted to the roof using E280 trims and the entire roof surface must be re-laminated.
- In bad cases, it may be necessary to grind down the ridges and fix new boards over the existing roof and re-laminate, ensuring adequate provision for board expansion with expansion joints on larger roofs and ability to fix into joists by minimum 40mm.

7) Tacky topcoat

Description of problem - Topcoat has suitable hardener and has been adequately mixed but is still tacky. This problem usually manifests itself in very hot conditions.

Possible cause

- This is usually caused by application of the top coat in hot, sunny conditions, so that the waxy surface layer cannot properly form.

Remedial action

- Clean down with acetone and re-apply in cooler conditions.
- Tacky topcoat usually occurs at approximately 5°C surface temperature and this is usually caused by very hot conditions and direct sunlight.

8) Colour fade of topcoat

Description of problem - This can take several years to appear and the problem may be worse if the topcoat was tacky when first laid.

Possible cause

- This is caused by erosion of the topcoat and is more likely to occur with darker colours.
- The effect of the colour returning when the surface is wet with rain is often reported.

Remedial action

- It may be possible to clean down, abrade and re-topcoat the roof, but it is difficult to guarantee that no topcoat delamination will occur thereafter.
- The only way to guarantee the longevity of the colour is to re-skin the roof with another laminate and re-topcoat.
- This is also a method for refurbishing old, damaged or well-worn roofs that may have been subjected to heavy foot traffic.

8) Pinholing

Description of problem - Pinholes appear on roof causing roof to leak in most cases.

Possible cause

- Too little resin being used during the laminating stage resulting in pinholes where the laminate has not been saturated with resin.
- Improper consolidation of the laminate resulting in small holes in the laminate where the resin has not been treated.

Remedial action

- During the consolidation of the laminate, extra care should be taken to identify any areas with small pinholes. If the laminate is not yet cured, more resin should be added and the area should be properly consolidated.
- If the area has cured, a section of new reinforcement mat should be torn to be used as a patch. Resin should be applied over the affected area and the patch should be laminated ensuring it is properly consolidated.
- Do not use topcoat to attempt to cover pinholed areas. This will not work!

Warm roof

2013 Part L regulation specification

2013 Part L Reg's Specification

A GRP roof can be easily configured in either a warm or cold roof specification. For a warm roof, a sub deck is first fixed to the joists at 300mm centres. A vapour check and insulation sheet is then laid over the top. Insulation sheets can also be purchased with a vapour check adhered to one side, following insulation manufacturer's guidelines for satisfactory bonding and fixing.

The decking should then be fixed on top as it normally would be. Screws should be used to fix the boards to the joists, these should penetrate through the insulation and into the joists by at least 40mm. It is imperative that all layers on the roof are pressed firmly together and that there are no gaps between any of the layers.

The GRP should then be laminated over the top of the roof, these roofs will usually require larger edge trim sizes such as A250 and B300. To comply with the Part L Regulations at the time of printing, the following specification would be required to obtain the following 'U' value as shown below.

12mm Ply Sub Deck

Based on Celotex FR5000 or equivalently specified insulation*

U= 0.20 - 95mm

U= 0.18 - 105mm

U= 0.15 - 130mm

U= 0.13 - 160mm

Or equivalently specified insulation

18mm T&G OSB3 Board

Cure It Glass Reinforced Laminate

*Based on λ (lambda) value of 0.21 from Celotex FR5000 2012 version

Warm roof application

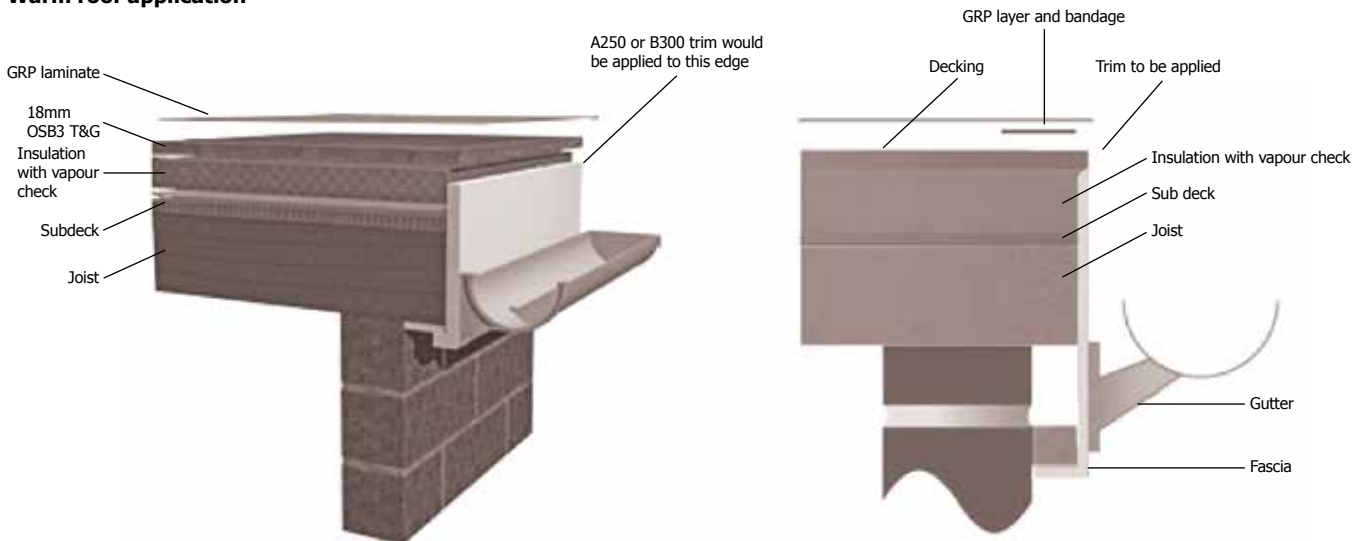

Warm roof

Application onto concrete or asphalt

Application instructions

When installing a warm roof onto a concrete substrate, it is important that the existing concrete or asphalt layer is completely dry, clean and in good condition. Battens the same thickness as the insulation boards used should be solidly attached to the concrete at 300mm centres. The Sterling board should then be fixed to the battens using the same fixings as would normally be used. Ensure there are no gaps between the layers. The laminate can then be laid over the top as normal.

Cross-section of warm roof onto concrete or asphalt

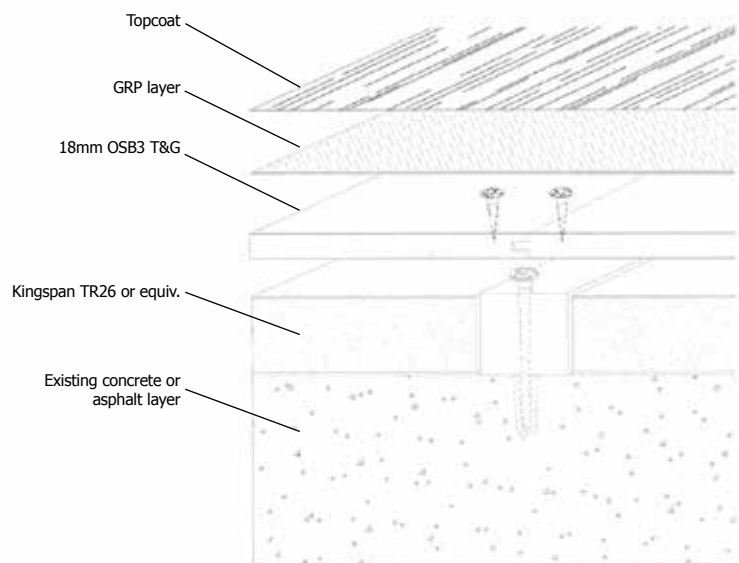
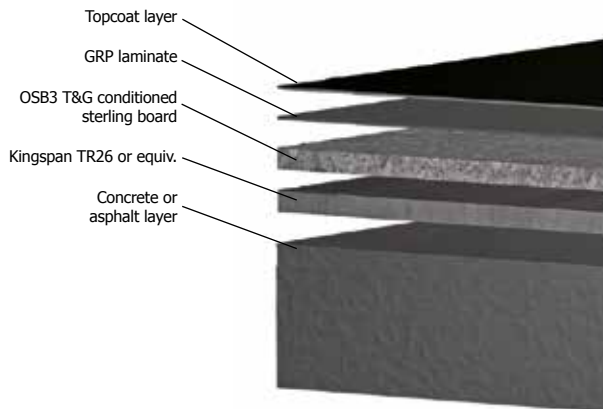

GRP Edge trims

E280 Expansion joint

The E280 trim is used both to create expansion joints on large roofs (over 100m²) and create rolls on any ridge details. It is compatible with C5 closures, C8B and C9A. At every 100m sq or 12 linear metres the decking should be gapped by 25mm to allow for expansion of the boards.

It is of critical importance that roofs of this size include extra structural reinforcement along the gapped area. This can be done in one of two ways:

- Where the decking is gapped, the joists underneath should have noggins installed at no more than 600mm centres with extra ones along the wall taking extra care to ensure that the joists are properly bedded/ fixed to the structure of the building. Each edge of the gapped decking is secured into the noggins with the standard 40mm penetration at 200mm centres in addition to the decking over the adjacent joists being fixed as usual.

or

- An extra joist timber can be fixed into the side of the joist over which the decking is gapped by 25mm. Each side of the board over the double thickness joist should be fixed into the joist at 200mm centres with 40mm penetration.

Do not laminate over the whole of the E280 trim, only over each of the flanges as this makes the trim more rigid.

The decking on either side of the expansion joint should not be allowed to 'float' freely as this will encourage undue expansion and potentially lead to cracking of the laminate.



E280 Application diagrams (2 options)

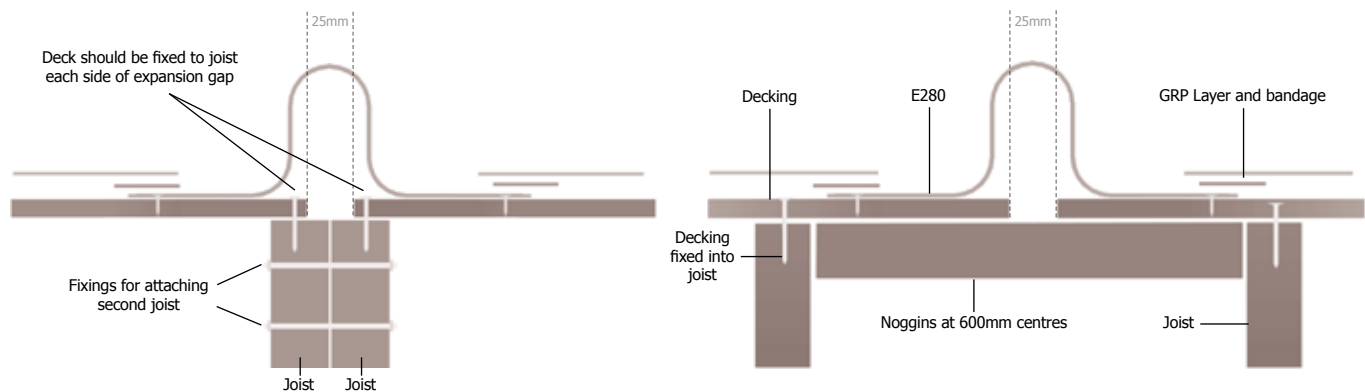

Joining a GRP roof to a felt roof

The E280 can also be used to bridge between a GRP and adjoining felt roof. The E280 should be fixed to the decking at the end of the GRP roof taking up the felt at the edge if possible to lay the trim underneath. The felt should be bonded to the trim with a liberal coating of Topflex acrylic roof coating both under and over the felt layer. You will then need a new piece of felt 400mm wide and the length of your trim. Wrap it over your trim from the GRP side and torch it onto the trim and existing felt (edge trim profiles are flame resistant) or bond it down using Topflex. This should be completed before the laminate is laid over the other edge of the trim.



C5 Closures

The C5 closure is used to close a run of E280 rolled joint trim. The closure should be overlapped by 50mm and sealed by a bead of trim adhesive. Nail to deck, bandage around edges and apply topcoat layer over the top.





CURE IT[®]

GRP WATERPROOFING SYSTEM



DOWNLOAD THE

CURE IT APP!
GRP WATERPROOFING SYSTEM

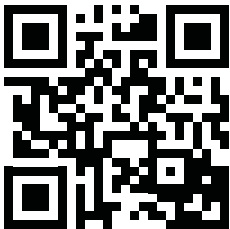

 Download on the
App Store

 Download on the
Android Market

Technical Support / Training

Available weekdays 08.30 - 16.30

Tel: 03301 222666

Email: technical@cureit.uk.com

Web: www.cureit.com

